



ELBOWS - NIPPLES - COUPLINGS



EMT

90° & 45° Set Screw Coupling Elbows

Features:

- Eliminates the use of couplings to save time and reduce overall cost
- Concrete tight when taped
- Pre-set & staked tri-head screws on all sizes

Standard Materials:
Steel

Standard Finish:
Zinc Plated

Applicable Third Party Standards:
UL Standard: 514B
UL Standard: 797

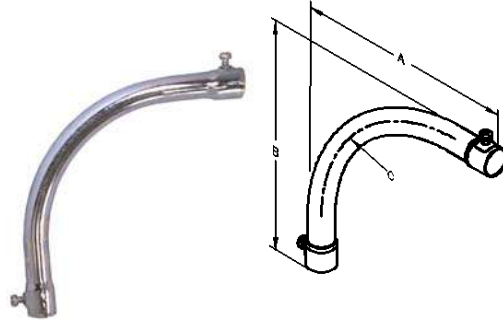

| CATALOG NUMBER | TRADE SIZE | DIM A | DIM B | DIM C | PCS/UNITS PER BOX |
|----------------|------------|---------|---------|---------|-------------------|
| 9840 | 1/2" | 6-1/2" | 6-1/2" | 4-1/2" | 50 |
| 9841 | 3/4" | 7-1/4" | 7-1/4" | 5" | 50 |
| 9842 | 1" | 8-1/2" | 8-1/2" | 6-1/4" | 20 |
| 9843 | 1-1/4" | 11-1/4" | 11-1/4" | 7-3/4" | 20 |
| 9844 | 1-1/2" | 12" | 12" | 9-1/4" | 15 |
| 9845 | 2" | 14-1/4" | 14-1/4" | 10-3/8" | 10 |

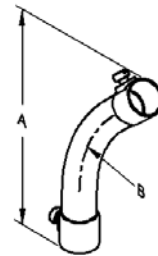

| CATALOG NUMBER | TRADE SIZE | DIM A | DIM B | PCS/UNITS PER BOX |
|----------------|------------|---------|--------|-------------------|
| 9850 | 1/2" | 7" | 4" | 50 |
| 9851 | 3/4" | 8-3/4" | 4-1/2" | 50 |
| 9852 | 1" | 10" | 5-3/4" | 20 |
| 9853 | 1-1/4" | 11-1/2" | 7-1/4" | 20 |
| 9854 | 1-1/2" | 14-3/4" | 8-1/4" | 15 |
| 9855 | 2" | 15" | 9-1/2" | 10 |

EMT

90° & 45° Elbows

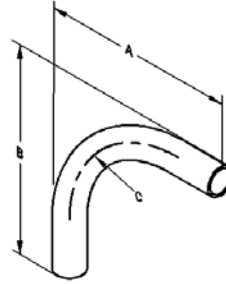

| CATALOG NUMBER | TRADE SIZE | DIM A | DIM B | DIM C | PCS/UNITS PER BOX |
|----------------|------------|---------|---------|---------|-------------------|
| 9860 | 1/2" | 6-3/8" | 6-3/8" | 4-1/4" | 50 |
| 9861 | 3/4" | 7-1/2" | 7-1/2" | 4-1/2" | 50 |
| 9862 | 1" | 9-1/2" | 9-1/2" | 6" | 20 |
| 9863 | 1-1/4" | 11-1/4" | 11-1/4" | 8" | 20 |
| 9864 | 1-1/2" | 13" | 13" | 9-1/8" | 15 |
| 9865 | 2" | 16" | 16" | 11-1/2" | 10 |
| 9866 | 2-1/2" | 18-1/2" | 18-1/2" | 11-3/4" | 1 |
| 9867 | 3" | 22-1/4" | 22-1/4" | 14-1/4" | 1 |
| 9868 | 3-1/2" | 25" | 25" | 17" | 1 |
| 9869 | 4" | 26" | 26" | 18-1/4" | 1 |

Standard Materials:
Steel

Standard /finish:
Zinc Plated

Applicable Third Party
Standards:
UL Standard: 797

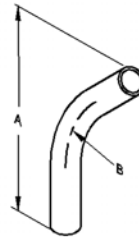

| CATALOG NUMBER | TRADE SIZE | DIM A | DIM B | PCS/UNITS PER BOX |
|----------------|------------|----------|---------|-------------------|
| 9870 | 1/2" | 6-9/16" | 4.0" | 50 |
| 9871 | 3/4" | 7-1/8" | 4-1/2" | 50 |
| 9872 | 1" | 8-9/16" | 5-3/4" | 20 |
| 9873 | 1-1/4" | 10-3/4" | 7-1/4" | 20 |
| 9874 | 1-1/2" | 11-1/2" | 8-1/4" | 15 |
| 9875 | 2" | 12-7/16" | 9-1/2" | 10 |
| 9876 | 2-1/2" | 13-9/16" | 10-1/2" | 1 |
| 9877 | 3" | 15-3/4" | 13" | 1 |
| 9878 | 3-1/2" | 17-1/2" | 15" | 1 |
| 9879 | 4" | 18-1/2" | 16" | 1 |



RIGID - IMC

90° Rigid Elbows & 45° Rigid Elbows

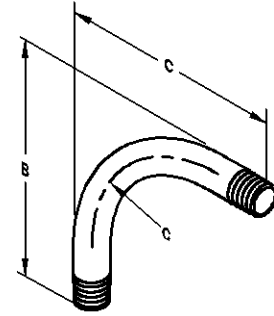

| CATALOG NUMBER | TRADE SIZE | DIM A | DIM R | PCS/UNITS PER BOX |
|----------------|------------|-------------|---------------|-------------------|
| 9820 | 1/2" | 2.00"/2.03" | 4.00"/4.04" | 50 |
| 9821 | 3/4" | 2.00"/2.03" | 4.50"/4.54" | 50 |
| 9822 | 1" | 2.25"/2.28" | 5.75"/5.80" | 20 |
| 9823 | 1-1/4" | 2.80"/2.83" | 7.25"/7.30" | 20 |
| 9824 | 1-1/2" | 2.80"/2.83" | 8.25"/8.31" | 10 |
| 9825 | 2" | 2.80"/2.83" | 9.50"/9.56" | 10 |
| 9826 | 2-1/2" | 4.00"/4.05" | 10.50"/10.56" | 1 |
| 9827 | 3" | 5.00"/5.05" | 13.00"/13.07" | 1 |
| 9828 | 3-1/2" | 6.00"/6.06" | 15.00"/15.08" | 1 |
| 9829 | 4" | 6.75"/6.81" | 16.00"/16.08" | 1 |

Features:
• NPT Threads

Standard Materials:
Steel

Standard Finish:
Zinc plated

Applicable Third Party Standards:
UL Standard: 6

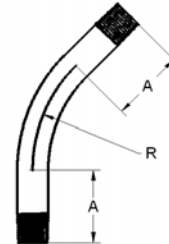

| CATALOG NUMBER | TRADE SIZE | DIM A | DIM R | PCS/UNITS PER BOX |
|----------------|------------|-------------|---------------|-------------------|
| 9830 | 1/2" | 2.00"/2.03" | 4.00"/4.04" | 50 |
| 9831 | 3/4" | 2.00"/2.03" | 4.00"/4.04" | 50 |
| 9832 | 1" | 2.25"/2.28" | 5.75"/5.80" | 35 |
| 9833 | 1-1/4" | 2.80"/2.83" | 7.25"/7.30" | 30 |
| 9834 | 1-1/2" | 2.80"/2.83" | 8.25"/8.31" | 15 |
| 9835 | 2" | 2.80"/2.83" | 9.50"/9.56" | 15 |
| 9836 | 2-1/2" | 4.00"/4.05" | 10.50"/10.56" | 1 |
| 9837 | 3" | 5.00"/5.05" | 13.00"/13.07" | 1 |
| 9838 | 3-1/2" | 6.00"/6.06" | 15.00"/15.08" | 1 |
| 9839 | 4" | 6.75"/6.81" | 16.00"/16.08" | 1 |

RIGID CONDUIT

Rigid Threaded Nipples



Use:
Threaded nipples are used to extend a length of threaded Rigid or IMC Conduit according to the pipe size and length desired. May also be used to connect two steel outlet boxes or metal enclosures together.

Materials
Zinc Plated Steel

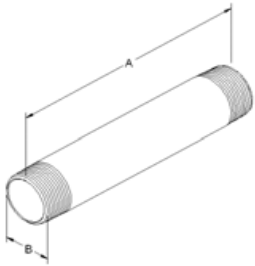

| Catalog Number | UPC No 0-87115 | Trade Size | Nominal Dimensions | | Ctn/Case Qty/Qty | Case Wt. |
|----------------|-------------------|------------|--------------------|---|------------------|----------|
| | | | A | B | | |

| <i>Boxed</i> | | | | | | |
|--------------|---------|--------|--------|----------|----|------|
| 9700 | 09700-2 | 1/2" | Close | 13/16" | 25 | 2.20 |
| 9701 | 09701-9 | 1/2" | 1-1/2" | 13/16" | 25 | 2.38 |
| 9702 | 09702-6 | 1/2" | 2" | 13/16" | 25 | 3.30 |
| 9703 | 09703-3 | 1/2" | 2-1/2" | 13/16" | 25 | 4.08 |
| 9704 | 09704-0 | 1/2" | 3" | 13/16" | 25 | 4.95 |
| 9705 | 09705-7 | 1/2" | 3-1/2" | 13/16" | 25 | 6.08 |
| 9706 | 09706-4 | 1/2" | 4" | 13/16" | 25 | 6.90 |
| 9707 | 09707-1 | 1/2" | 5" | 13/16" | 25 | 8.50 |
| 9708 | 09708-8 | 1/2" | 6" | 13/16" | 1 | 0.49 |
| 9709 | 09709-5 | 1/2" | 8" | 13/16" | 1 | 0.55 |
| 9710 | 09710-1 | 1/2" | 10" | 13/16" | 1 | 0.70 |
| 9711 | 09711-8 | 1/2" | 12" | 13/16" | 1 | 0.84 |
| 9712 | 09712-5 | 3/4" | Close | 1-1/16" | 25 | 3.03 |
| 9713 | 09713-2 | 3/4" | 2" | 1-1/16" | 25 | 3.58 |
| 9714 | 09714-9 | 3/4" | 2-1/2" | 1-1/16" | 25 | 4.68 |
| 9715 | 09715-6 | 3/4" | 3" | 1-1/16" | 25 | 5.80 |
| 9716 | 09716-3 | 3/4" | 3-1/2" | 1-1/16" | 25 | 7.18 |
| 9717 | 09717-0 | 3/4" | 4" | 1-1/16" | 25 | 8.28 |
| 9718 | 09718-7 | 3/4" | 5" | 1-1/16" | 25 | 10.5 |
| 9719 | 09719-4 | 3/4" | 6" | 1-1/16" | 1 | 0.53 |
| 9720 | 09720-0 | 3/4" | 8" | 1-1/16" | 1 | 0.70 |
| 9721 | 09721-7 | 3/4" | 10" | 1-1/16" | 1 | 0.88 |
| 9722 | 09722-4 | 3/4" | 12" | 1-1/16" | 1 | 1.06 |
| 9723 | 09723-1 | 1" | Close | 1-5/16" | 25 | 3.58 |
| 9724 | 09724-8 | 1" | 2" | 1-5/16" | 25 | 4.40 |
| 9725 | 09725-5 | 1" | 2-1/2" | 1-5/16" | 25 | 6.60 |
| 9726 | 09726-2 | 1" | 3" | 1-5/16" | 25 | 8.28 |
| 9727 | 09727-9 | 1" | 3-1/2" | 1-5/16" | 25 | 9.93 |
| 9728 | 09728-6 | 1" | 4" | 1-5/16" | 25 | 11.6 |
| 9729 | 09729-3 | 1" | 5" | 1-5/16" | 25 | 14.9 |
| 9730 | 09730-9 | 1" | 6" | 1-5/16" | 25 | 18.1 |
| 9731 | 09731-6 | 1" | 8" | 1-5/16" | 1 | 0.99 |
| 9732 | 09732-3 | 1" | 10" | 1-5/16" | 1 | 1.25 |
| 9733 | 09733-0 | 1" | 12" | 1-5/16" | 1 | 1.52 |
| 9734 | 09734-7 | 1-1/4" | Close | 1-11/16" | 25 | 4.95 |
| 9735 | 09735-4 | 1-1/4" | 2" | 1-11/16" | 25 | 5.53 |
| 9736 | 09736-1 | 1-1/4" | 2-1/2" | 1-11/16" | 25 | 8.28 |
| 9737 | 09737-8 | 1-1/4" | 3" | 1-11/16" | 25 | 10.5 |
| 9738 | 09738-5 | 1-1/4" | 3-1/2" | 1-11/16" | 25 | 14.3 |
| 9739 | 09739-2 | 1-1/4" | 4" | 1-11/16" | 25 | 15.4 |
| 9740 | 09740-8 | 1-1/4" | 5" | 1-11/16" | 25 | 19.9 |
| 9741 | 09741-5 | 1-1/4" | 6" | 1-11/16" | 25 | 23.7 |
| 9742 | 09742-2 | 1-1/4" | 8" | 1-11/16" | 1 | 1.35 |
| 9743 | 09743-9 | 1-1/4" | 10" | 1-11/16" | 1 | 1.72 |
| 9744 | 09744-6 | 1-1/4" | 12" | 1-11/16" | 1 | 2.07 |
| 9745 | 09745-3 | 1-1/2" | Close | 1-7/8" | 25 | 5.53 |
| 9746 | 09746-0 | 1-1/2" | 2" | 1-7/8" | 25 | 6.08 |
| 9747 | 09747-7 | 1-1/2" | 2-1/2" | 1-7/8" | 25 | 8.28 |
| 9748 | 09748-4 | 1-1/2" | 3" | 1-7/8" | 25 | 11.0 |
| 9749 | 09749-1 | 1-1/2" | 3-1/2" | 1-7/8" | 25 | 13.2 |
| 9750 | 09750-7 | 1-1/2" | 4" | 1-7/8" | 25 | 16.5 |
| 9751 | 09751-4 | 1-1/2" | 5" | 1-7/8" | 25 | 21.5 |
| 9752 | 09752-1 | 1-1/2" | 6" | 1-7/8" | 1 | 1.08 |
| 9753 | 09753-8 | 1-1/2" | 8" | 1-7/8" | 1 | 1.52 |
| 9754 | 09754-5 | 1-1/2" | 10" | 1-7/8" | 1 | 1.96 |
| 9755 | 09755-2 | 1-1/2" | 12" | 1-7/8" | 1 | 2.38 |

RIGID CONDUIT

RIGID CONDUIT

Rigid Threaded Nipples



Use:
Threaded nipples are used to extend a length of threaded Rigid or IMC Conduit according to the pipe size and length desired. May also be used to connect two steel outlet boxes or metal enclosures together.

Materials
• Zinc Plated Steel

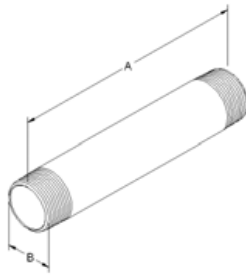

Threaded Couplings

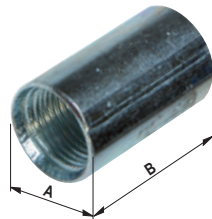

Use:
Threaded couplings are used to join two lengths of threaded Rigid or IMC Conduit.

Materials
• Steel

Finish
• Galvanized

| Catalog Number | UPC No 0-87115 | Trade Size | Nominal Dimensions | | Ctn/Case Qty/Qty | Case Wt. |
|----------------|----------------|------------|--------------------|--------|------------------|----------|
| | | | A | B | | |
| Boxed | | | | | | |
| 9756 | 09756-9 | 2" | Close | 2-3/8" | 25 | 9.93 |
| 9757 | 09757-6 | 2" | 2-1/2" | 2-3/8" | 25 | 10.3 |
| 9758 | 09758-3 | 2" | 3" | 2-3/8" | 25 | 14.3 |
| 9759 | 09759-0 | 2" | 3-1/2" | 2-3/8" | 25 | 17.7 |
| 9760 | 09760-6 | 2" | 4" | 2-3/8" | 25 | 22.1 |
| 9761 | 09761-3 | 2" | 5" | 2-3/8" | 25 | 28.7 |
| 9762 | 09762-0 | 2" | 6" | 2-3/8" | 1 | 1.43 |
| 9763 | 09763-7 | 2" | 8" | 2-3/8" | 1 | 2.03 |
| 9764 | 09764-4 | 2" | 10" | 2-3/8" | 1 | 2.82 |
| 9765 | 09765-1 | 2" | 12" | 2-3/8" | 1 | 3.26 |
| 9766 | 09766-8 | 2-1/2" | Close | 2-7/8" | 1 | 0.61 |
| 9767 | 09767-5 | 2-1/2" | 3" | 2-7/8" | 1 | 0.64 |
| 9768 | 09768-2 | 2-1/2" | 3-1/2" | 2-7/8" | 1 | 0.88 |
| 9769 | 09769-9 | 2-1/2" | 4" | 2-7/8" | 1 | 1.12 |
| 9770 | 09770-5 | 2-1/2" | 5" | 2-7/8" | 1 | 1.57 |
| 9771 | 09771-2 | 2-1/2" | 6" | 2-7/8" | 1 | 2.05 |
| 9772 | 09772-9 | 2-1/2" | 8" | 2-7/8" | 1 | 2.98 |
| 9773 | 09773-6 | 2-1/2" | 10" | 2-7/8" | 1 | 3.92 |
| 9774 | 09774-3 | 2-1/2" | 12" | 2-7/8" | 1 | 4.87 |
| 9775 | 09775-0 | 3" | Close | 3-1/2" | 1 | 0.77 |
| 9776 | 09776-7 | 3" | 3" | 3-1/2" | 1 | 0.86 |
| 9777 | 09777-4 | 3" | 3-1/2" | 3-1/2" | 1 | 1.15 |
| 9778 | 09778-1 | 3" | 4" | 3-1/2" | 1 | 1.48 |
| 9779 | 09779-8 | 3" | 5" | 3-1/2" | 1 | 2.05 |
| 9780 | 09780-4 | 3" | 6" | 3-1/2" | 1 | 2.62 |
| 9781 | 09781-1 | 3" | 8" | 3-1/2" | 1 | 3.79 |
| 9782 | 09782-8 | 3" | 10" | 3-1/2" | 1 | 4.96 |
| 9783 | 09783-5 | 3" | 12" | 3-1/2" | 1 | 5.75 |
| 9784 | 09784-2 | 3-1/2" | Close | 4" | 1 | 0.88 |
| 9785 | 09785-9 | 3-1/2" | 4" | 4" | 1 | 2.03 |
| 9786 | 09786-6 | 3-1/2" | 5" | 4" | 1 | 2.49 |
| 9787 | 09787-3 | 3-1/2" | 6" | 4" | 1 | 3.15 |
| 9788 | 09788-0 | 3-1/2" | 8" | 4" | 1 | 4.50 |
| 9789 | 09789-7 | 3-1/2" | 10" | 4" | 1 | 5.84 |
| 9790 | 09790-3 | 3-1/2" | 12" | 4" | 1 | 7.19 |
| 9791 | 09791-0 | 4" | Close | 4-1/2" | 1 | 1.15 |
| 9792 | 09792-7 | 4" | 4" | 4-1/2" | 1 | 2.03 |
| 9793 | 09793-4 | 4" | 5" | 4-1/2" | 1 | 2.80 |
| 9794 | 09794-1 | 4" | 6" | 4-1/2" | 1 | 3.57 |
| 9795 | 09795-8 | 4" | 8" | 4-1/2" | 1 | 5.18 |
| 9796 | 09796-5 | 4" | 10" | 4-1/2" | 1 | 6.68 |
| 9797 | 09797-2 | 4" | 12" | 4-1/2" | 1 | 8.25 |

RIGID CONDUIT

| Catalog Number | UPC No 0-87115 | Trade Size | Nominal Dimensions | | Ctn/Case Qty/Qty | Case Wt. |
|----------------|----------------|------------|--------------------|---------|------------------|----------|
| | | | A | B | | |
| Boxed | | | | | | |
| 9000 | 09000-3 | 1/2" | 1 5/8" | 1" | 100 | 12.6 |
| 9001 | 09001-0 | 3/4" | 1 5/8" | 1 1/4" | 50 | 8.0 |
| 9002 | 09002-7 | 1" | 2" | 1 1/2" | 30 | 8.3 |
| 9003 | 09003-4 | 1 1/4" | 2 1/16" | 1 7/8" | 25 | 8.3 |
| 9004 | 09004-1 | 1 1/2" | 2 1/8" | 2 1/8" | 25 | 11.0 |
| 9005 | 09005-0 | 2" | 2 3/16" | 2 5/8" | 20 | 14.1 |
| 9006 | 09006-5 | 2 1/2" | 3 3/16" | 3 3/16" | 12 | 20.4 |
| 9007 | 09007-2 | 3" | 3 13/16" | 3 1/4" | 8 | 16.4 |
| 9008 | 09008-9 | 3 1/2" | 4 1/2" | 3 7/16" | 4 | 10.6 |
| 9009 | 09009-6 | 4" | 4 13/16" | 3 1/2" | 4 | 13.9 |



A Leading Manufacturer of Electrical Fittings Products